

mUSD-300-15

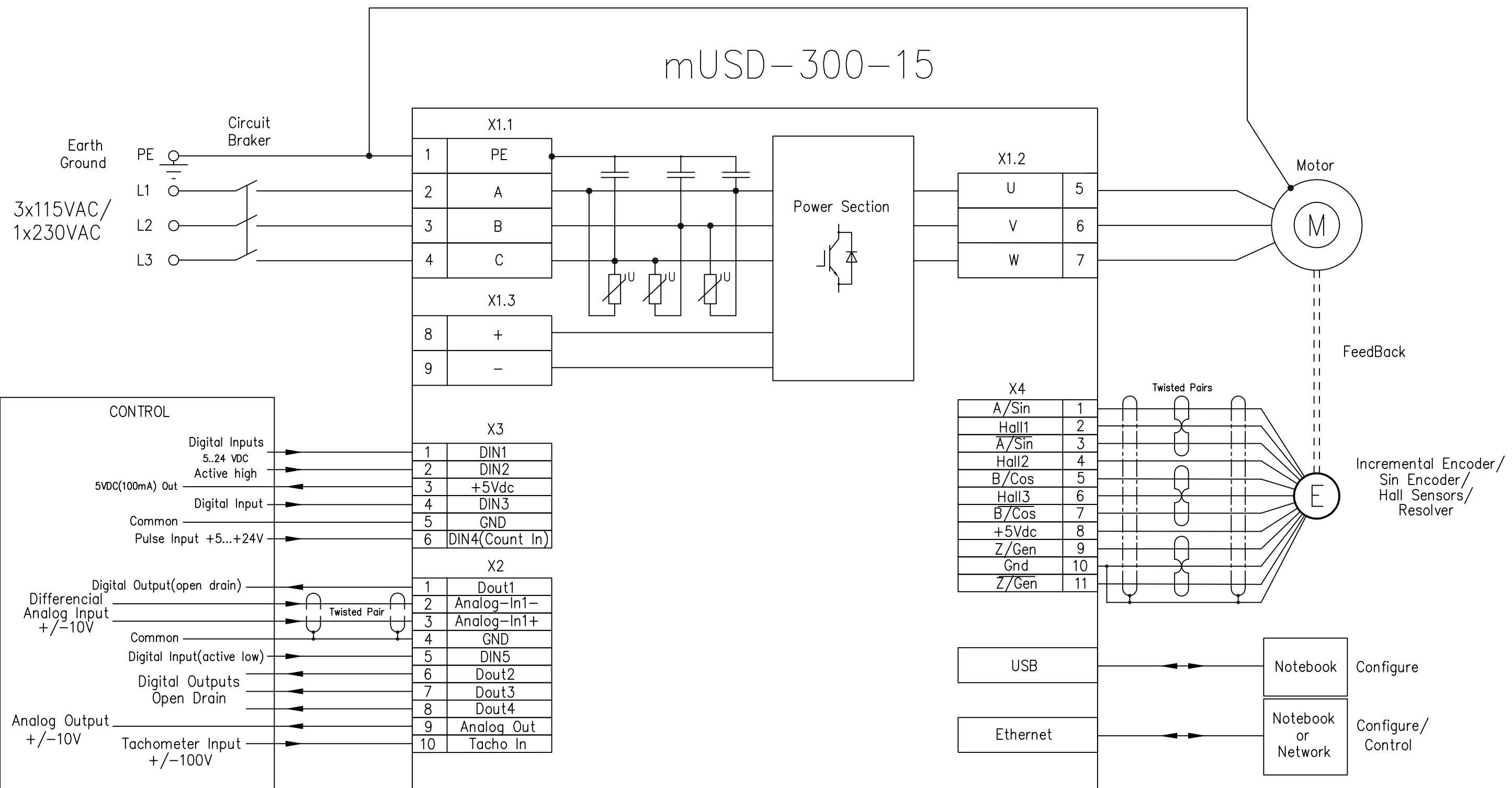

Earth Ground
 PE
 3x115VAC/
 1x230VAC
 L1
 L2
 L3

Circuit
 Braker

X1.1	
1	PE
2	A
3	B
4	C

X1.3	
8	+
9	-

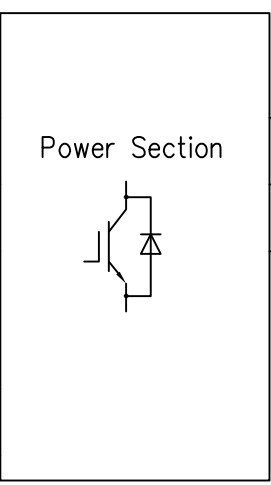

X1.2	
U	5
V	6
W	7

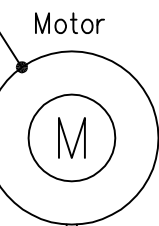

FeedBack

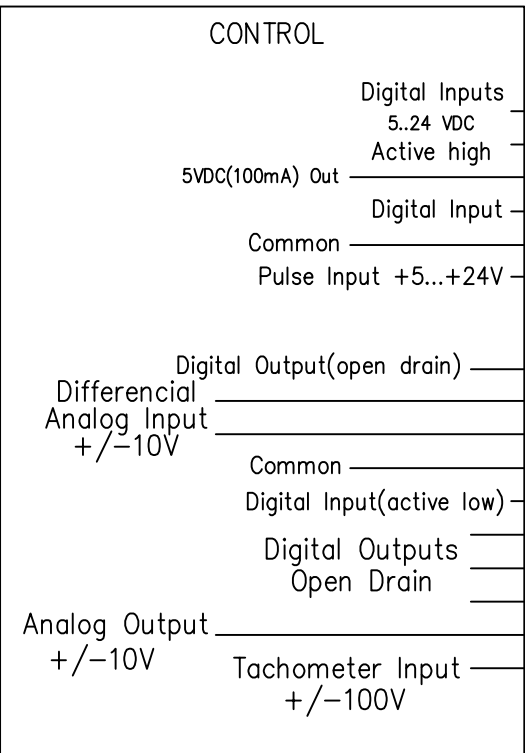

X3	
1	DIN1
2	DIN2
3	+5Vdc
4	DIN3
5	GND
6	DIN4(Count In)

X2	
1	Dout1
2	Analog-In1-
3	Analog-In1+
4	GND
5	DIN5
6	Dout2
7	Dout3
8	Dout4
9	Analog Out
10	Tacho In

X4	
A/Sin	1
Hall1	2
A/Sin	3
Hall2	4
B/Cos	5
Hall3	6
B/Cos	7
+5Vdc	8
Z/Gen	9
Gnd	10
Z/Gen	11

Twisted Pairs

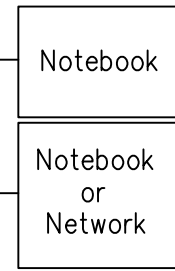
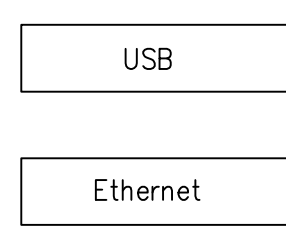
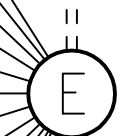

Configure

Configure/
 Control